

SH-4J

6-24X50 FFP

Product Manual



ARKEN OPTICS

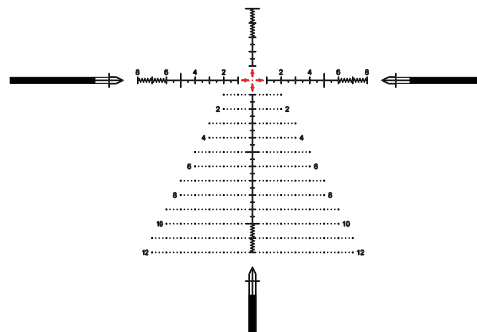

ARKEN OPTICS USA

www.arkenopticsusa.com

ARKEN OPTICS GLOBAL

www.arkenoptics.com

Table of Contents

Welcome	01
6-24X50 Specifications	02
Identification / Characteristics	03
Mounting Tips and Tricks	04
Focusing the SH-4J / Setting the Diopter	05
Magnification Ring	05
Sunshade	05
Parallax	06
Illumination Knob	06
Elevation And Windage Turrets	06
Windage and Elevation Adjustments	07
Instructions For Use	08
Zero-Reset (Tool-Less)	08
The Subtension Scale: MIL or MOA	09
VHR Reticle	10
VPR Reticle	11
Measurement Reference	12



Ensure your firearm is unloaded before proceeding. If you pause use and then resume later, reconfirm that the chamber is still empty.

Welcome

SH-4J 6-24X50 FFP

Arken products are designed to combine quality, performance, and precision with tremendous value. The SH-4J raises the bar, now coming standard with Japanese ELD glass and choice of reticle (VPR or VHR). Like its predecessor, The SH-4J incorporates adjustable elevation and windage turrets with tactile and audible clicks. These turrets offer 8 MILS/20 MOA per revolution.

- Lifetime Warranty
- Precision Tracking Guaranteed
- Japanese ELD glass
- First Focal Plane (FFP)
- Zero Stop



Specifications



6-24X50

Magnification:	6-24x	Reticle Details:	VHR MIL / VHR MOA / VPR MIL / VPR MOA
Objective Diameter:	50 mm	Elevation Adj. Range:	30 MRAD / 100 MOA
Eye Relief:	3.5 inches	Windage Adj. Range:	16 MRAD / 60 MOA
Field of View:	18.55-4.65 ft@100 Yards	Elevation Adj. Per Revolution:	8 MRAD / 20 MOA
Tube Size:	34 mm	Windage Adj. Per Revolution:	8 MRAD / 20 MOA
Turret Adjustment:	0.1 MRAD / 0.25 MOA	Parallax:	Side Parallax Adjustments, 20Yds-Infinity
Reticle Position:	First Focal Plane	Illuminated Reticle:	Red
Zero Stop:	AZS Zero Stop System	Turret Rotation:	Counter Clockwise (CCW)
Zero Reset:	Yes	Length:	13.875 inches
Battery Model:	CR2032	Weight:	36 oz

Identification / Characteristics



- A** Eyepiece / Ocular Lens
- B** Diopter / Ocular Focus Ring
- C** Magnification Ring
- D** Parallax
- E** Illumination Knob
- F** Elevation Turret (Turret caps screw over turret)
- G** Windage Turret (Turret caps screw over turret)
- H** Objective Lens

Mounting Tips and Tricks



When it comes to securing your SH-4J to your firearm, getting it right the first time is crucial for accurate shooting. Here are some tips and tricks to ensure your scope is mounted correctly on your rifle.

- 🔺 **We recommend using ARKEN OPTICS Mounts or Rings:** Select mounts designed to complement ARKEN scopes, ensuring a seamless and stable connection between your scope and rifle.
- 🔺 **Clean and Degrease:** Before mounting, clean the mounting surfaces on both the rifle and the scope. Remove any old oil or residue to ensure a solid connection.
- 🔺 **Torque Wrench is Your Friend:** Use a torque wrench to tighten screws to the recommended specifications. This ensures consistent pressure and prevents over-tightening.
- 🔺 **Properly Level the Scope:** A leveling tool helps ensure the scope is perfectly aligned with the rifle. This step is often overlooked but is crucial for accuracy.
- 🔺 **Eye Relief:** Position the scope to achieve the proper eye relief for your shooting style. This is the distance between your eye and the scope.
- 🔺 **Bore Sighting:** Before finalizing the mounting, perform a bore sight. This gets your scope on paper before you head to the range for fine-tuning.
- 🔺 **Recheck and Test:** After mounting, recheck all screws for tightness. Take your rifle to the range and test for accuracy.
- 🔺 **Consider Recoil:** If you're mounting on a high-recoil rifle, ensure there's enough eye relief to prevent scope bite.
- 🔺 **Apply Thread Locker Sparingly:** Use a small amount of thread locker on screws and bolts to prevent them from loosening due to recoil vibrations. Gently apply Thread locker. We recommend blue locktite.
- 🔺 **Consult a Professional:** If you're unsure, seek advice from a professional gun smith. They can ensure your scope is mounted perfectly.

A well-mounted scope can make a world of difference in your shooting experience. Following these tips will help you achieve the best results with your scope.

Eyepiece/Diopter

To adjust reticle focus, rotate the diopter ring while looking at an unobstructed background, and it's recommended to use the sky as background. Your eye will continually refocus at the reticle, so this should be done in short intervals. Look away between each adjustment to allow your eye to focus back on the sky. Then quickly look back at the reticle and make the necessary diopter adjustment. The reticle should appear to be sharp and should not appear to move when you move your head. Once properly set, the eye should not have to work to get the reticle in focus.



Magnification Ring

To obtain the desired magnification, rotate the Magnification Ring so that the indicator on the Ring corresponds with the magnification power level on the scope body.

Sunshade

Is provided to reduce the reflection and glare off the objective lens. It can also help to protect the lens from being hit or scratched.



Parallax

To eliminate parallax, rotate the Parallax knob. Proper adjustment will eliminate all reticle movement within the eye box. Note that the distance indicated on the parallax knob may not be exact but is to be used as a guide. Fine tune the parallax adjustment by looking through the scope.



Illumination Knob

In low light or low contrast conditions, you can turn on the illuminated reticle. The reticle will turn red to facilitate observation and aiming. The multiple different brightness levels are provided for various lighting conditions. The illumination is powered by a single CR2032 battery.

Elevation And Windage Turrets

The elevation turret moves the reticle up or down, and the windage turret moves the reticle left and right. Rotate the elevation turret counterclockwise to move the reticle up and clockwise to move the reticle down. Rotate the windage turret clockwise to move the reticle left, counterclockwise to move the reticle right.



Windage and Elevation Adjustments



Making precise adjustments to windage (horizontal) and elevation (vertical) settings on your SH-4J scope is crucial for achieving accurate shots. Following are the quick guidance of the process:

1. Locate the Turrets:

Identify the windage and elevation turrets on the scope body. Looking directly at the eyepiece, the windage turret is located on the right side, and the elevation turret is on top. The windage and elevation turrets are the only turrets that have caps on them that cover them completely.

2. Understand the Directional Movements:

Windage: Turning the windage turret clockwise moves the point of impact to the left and counter clockwise moves it to the right.

Elevation: Rotating the elevation turret clockwise lowers the point of impact and counterclockwise raises it.

3. Making Adjustments:

Windage: Use the windage turret to move the point of impact horizontally, aligning it with your point of aim.

Elevation: Utilize the elevation turret to adjust the point of impact vertically, aligning it with your point of aim.

4. Recording Changes:

Keep track of the adjustments made. Scopes use Minute of Angle (MOA) or Milliradian (MRAD) measurements for precision.

5. Fine-Tuning:

Fire additional shots, making minor adjustments as needed to achieve the desired point of impact.

Remember, each click of the turret represents a specific angular measurement.

It's recommended to get familiar with the scope specifications and ballistic calculations for more accurate adjustment.

Instructions For Use



Sight In

1. Bore-Sighting Preparation:

Begin by bore-sighting your rifle. This helps to get your initial shots are close to the point of aim.

2. Firing Initial Rounds:

Fire a series of three to five rounds at the target.

3. Measure POA VS POI:

Determine the difference between the point of aim (POA) and the point of impact (POI). Use the reticle or a measuring directly on the target with a ruler.

4. Adjust Elevation and Windage:

Using the adjustment turrets, make the necessary changes to move the POA to the POI.

5 Confirmation Rounds:

Fire an additional three to five rounds to verify your zero. Continue making adjustments until the POA and POI coincide.



Zero-Reset

After you have zeroed the scope, loosen the screw of the elevation turret, then remove the turret cap. Realign the 0 position of the cap with the scale line on the scope body, and re-tighten the screws of the elevation turret.

The Subtension Scale: MIL or MOA



MRAD(Milliradian): 1/1000th of 1 radian of arc

1MIL= 3.438 MOA

1MIL= 3.599 inches @ 100 yards

1/10 MIL = 0.359 inches @ 100 yards

MOA							
100 yds	200 yds	300 yds	400 yds	500 yds	600 yds	700 yds	800 yds
1"	2"	3"	4"	5"	6"	7"	8"

MRAD							
100 yds	200 yds	300 yds	400 yds	500 yds	600 yds	700 yds	800 yds
3.6"	7.2"	10.8"	14.4"	18"	21.6"	25.2"	28.8"

VHR Reticle

For shooters who prioritize a clear view of their target, the VHR reticle's open design is a significant advantage. It ensures that the point of impact (POI) and the target are always visible and unobstructed. This aspect of the VHR makes it particularly well-suited for hunting environments, where a quick, unimpeded sight picture is crucial. The VHR's intuitive layout facilitates quick target acquisition, making it a practical choice for anyone seeking both simplicity and effectiveness in their optics.

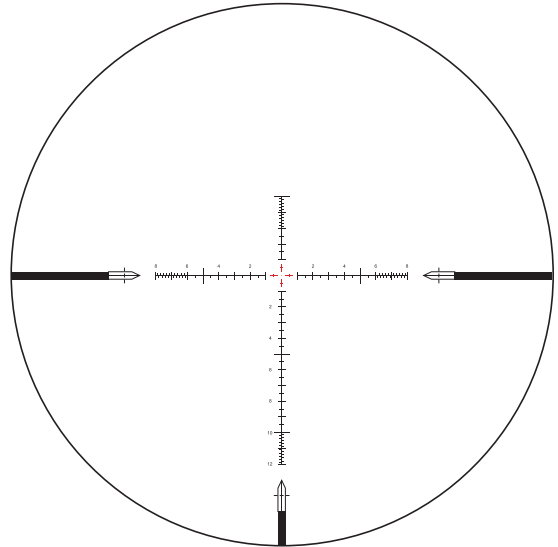

VPR Reticle

The VPR reticle design was crafted by ARKEN OPTICS to elevate long-range shooting accuracy. Featuring a grid of small points along both vertical and horizontal axes, it provides a comprehensive hold-over system. This proves particularly advantageous for shooters involved in rapid firing or requiring swift windage adjustments in multi-target scenarios.

At the center of the reticle is a finely detailed 0.04 MIL (or 0.14 MOA) dot, ensuring unparalleled precision for long-distance shots or when targeting smaller objects. Furthermore, the center dot and the immediate 1 MIL (or 4 MOA) area surrounding it can be illuminated in red, enhancing visibility and focus.

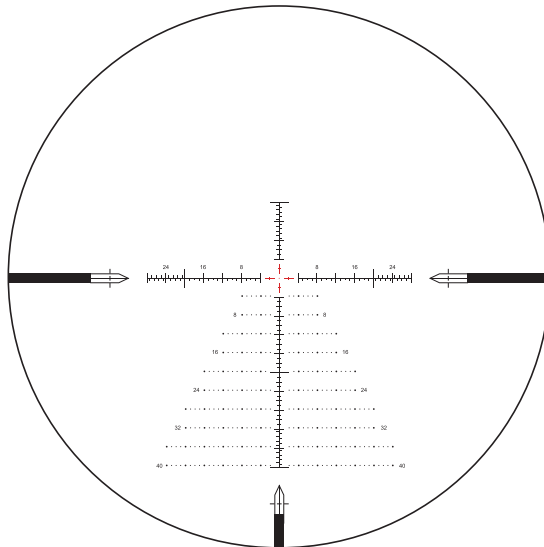

SH-4J

Measurement Reference

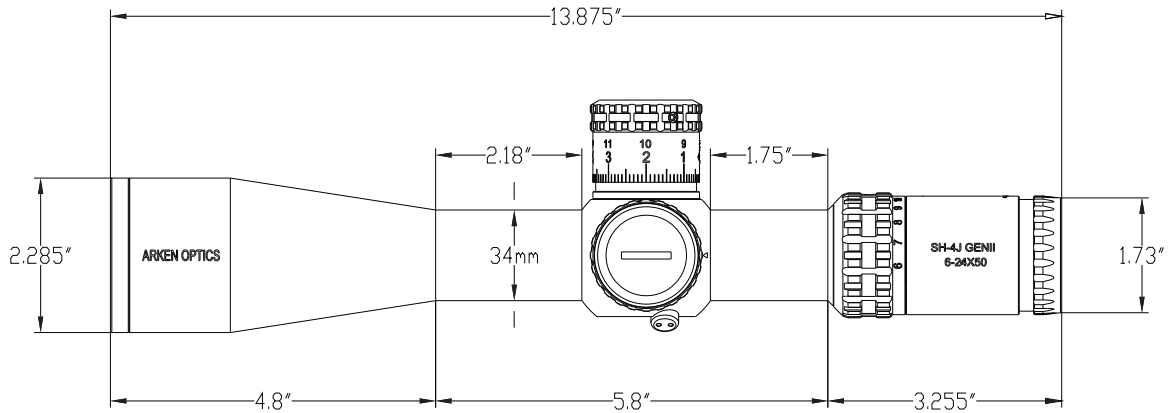







RUGGED PRECISION







All trademarks, graphics, and designs herein are the property of **ARKEN OPTICS**. Product specifications are subject to change without notice. Product manual is subject to change without notice. Products received may differ in appearance from those shown. ARKEN OPTICS is not responsible for typographical errors, data errors, or user ability/execution. ARKEN OPTICS is not responsible for results in real-time execution due to user ability.

○ ARKEN OPTICS GLOBAL

 www.facebook.com/arkenopticsglobal
 www.instagram.com/arken_optics_global/
 www.youtube.com/@ArkenOpticsGlobal
 info@arkenoptics.com
 www.arkenoptics.com

○ ARKEN OPTICS USA

 www.facebook.com/ArkenOpticsUSA
 www.instagram.com/arkenopticsusa/
 www.youtube.com/@ArkenOpticsUsa
 info@arkenopticsusa.com
 www.arkenopticsusa.com